

Benötigte Werkzeuge – Outils Nécessaires – Tools Required – Attrezzi Necessari

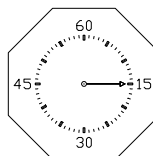

A x1

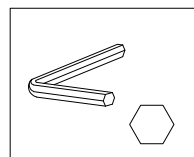
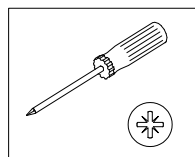
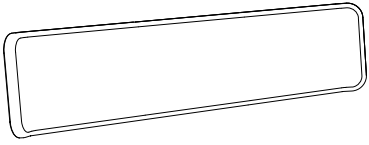

B x2

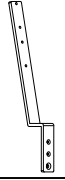

790.010

C x4

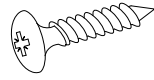

631.16500

D x2

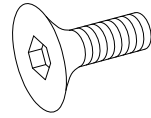

631.10600

E x2

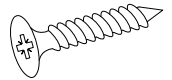

631.321

1.

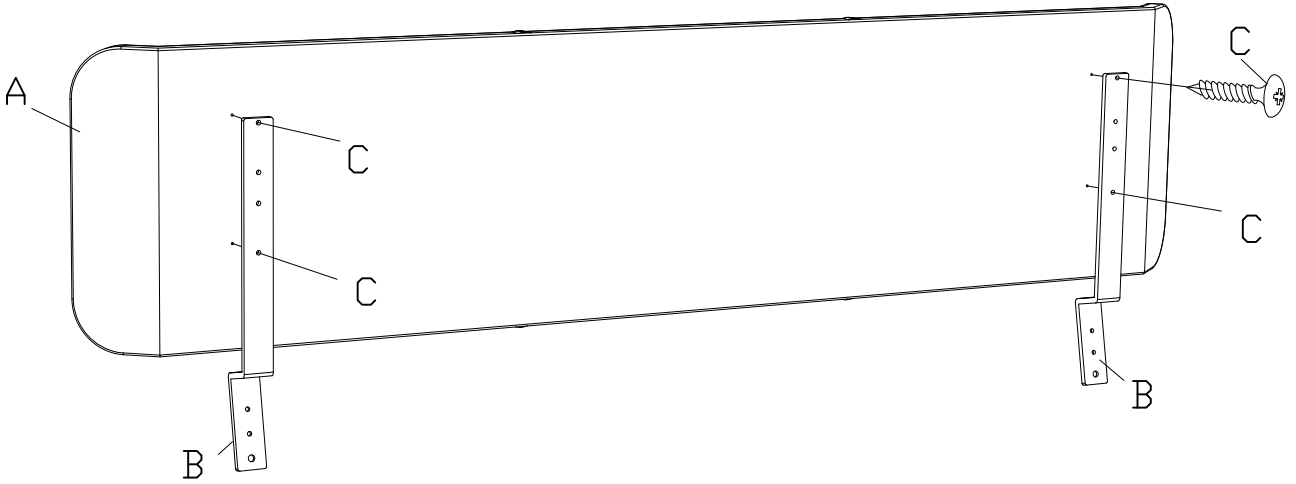

2.

1.

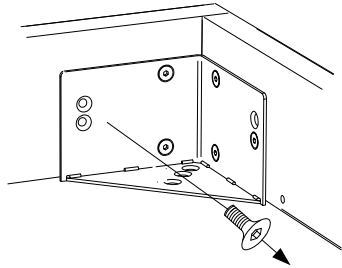

2.

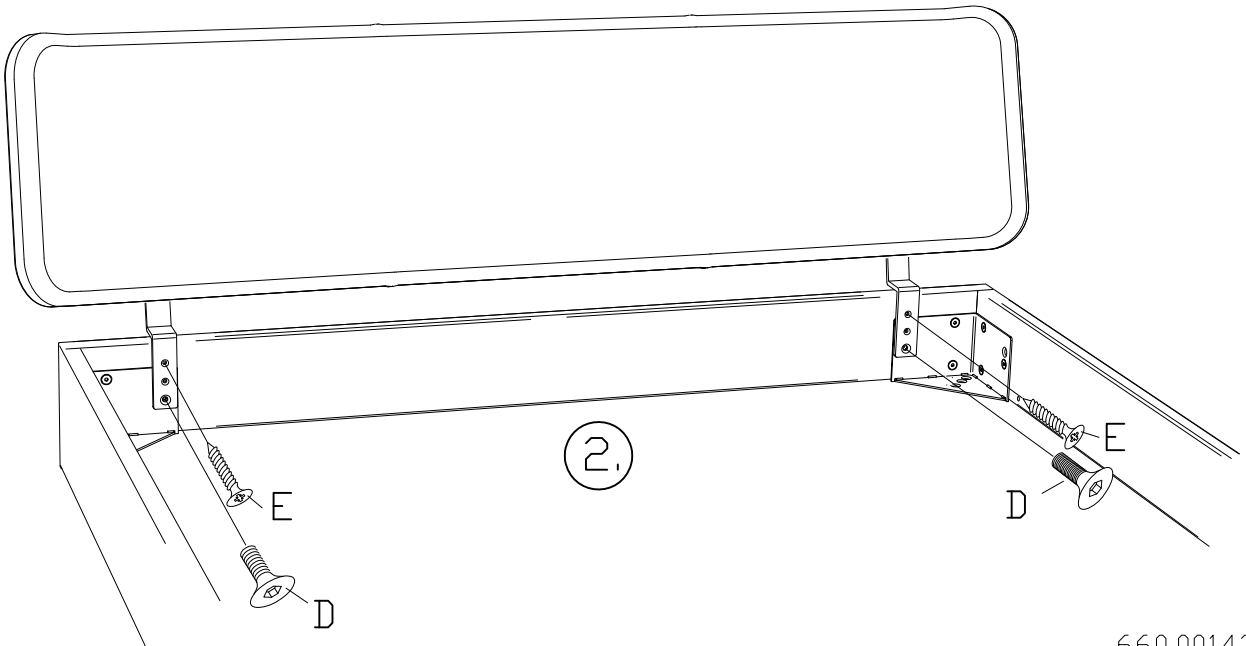

660.00143