

Service

Name **BARCELONA**
 Typ **T83 - GARDEROBENSCHRANK**

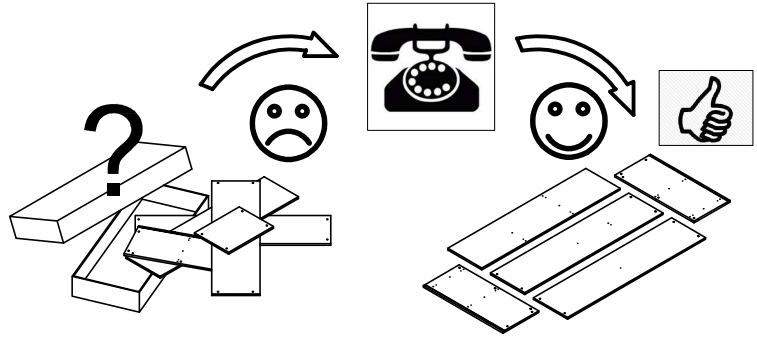
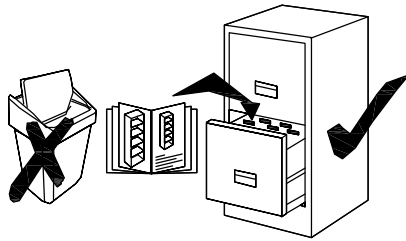

- ① 752x372x38
- ② 666x330x25
- ③ 712x352x29
- ④ 752x372x28
- ⑤ 1934x352x19
- ⑥ 1934x352x19
- ⑦ 712x320x18
- ⑧ 710x290x18
- ⑨ 1929x296x20
- ⑩ 1929x445x20
- ⑪ 1921x728x3
- ⑫ 60x60x15
- ⑬ 711x15x10
- ⑭ 690x342x342 - **Beleuchtung!!**

⑮ **Trafo!!**

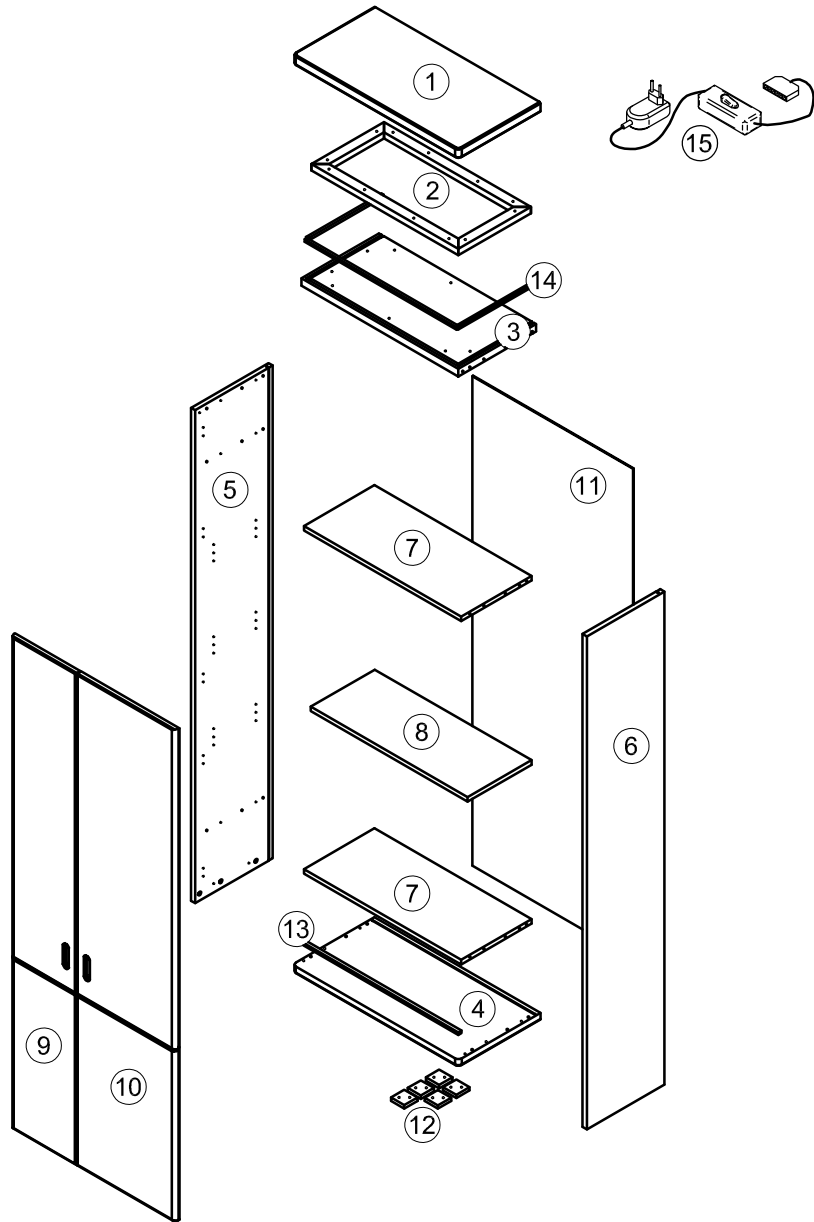
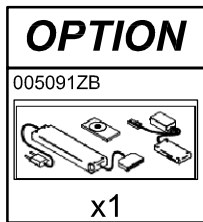

D1 Ø8x32 mm 	A2 60x20x15 mm 	ES 6,3x13 mm 	S2-40 4x40mm
EX Ø15x12 mm 	S1 -16 3,0x16 mm 	PG 64 mm 	S2-35 4x35mm
T1 	B 	W1 	S2-30 4x30 mm
GL 	ST 	S -16 3,5x16 mm 	H1
			S2-16L 4x16 mm
			M20 M4x20 mm
			C2
			M1
			VI 260mm
			P1

Modellname: BARCELONA

MONTAGEANLEITUNG TYPE T83 - GARDEROBENSCHRANK

1/1

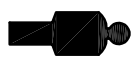

1 Person

10
Min.

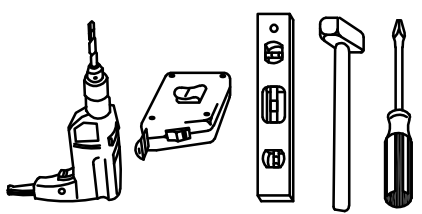

(M20) M4x20 mm x4	(W1) x4
(C2) x20	(PG) 64 mm x2
(S2-16L) 4x16 mm x2	(ST) x4
(A2) 60x20x15 mm x2	

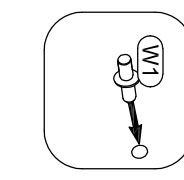
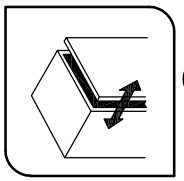
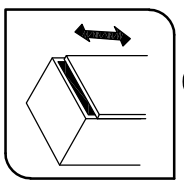
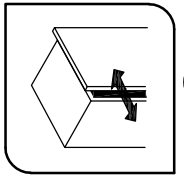
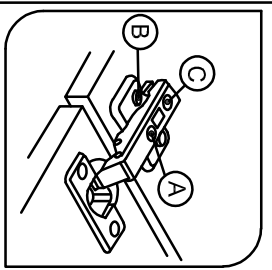
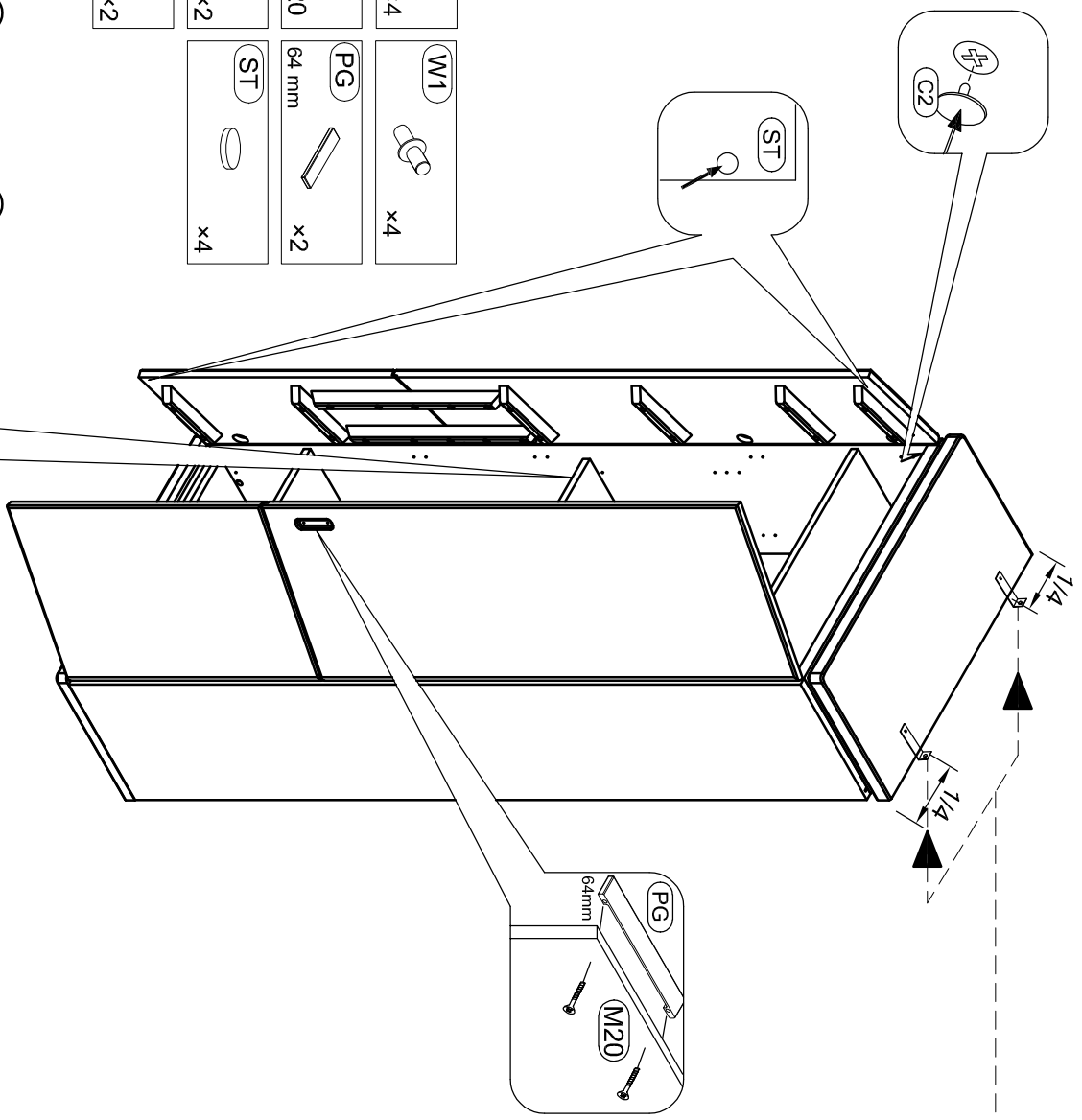

- 1.
- 2.
- 3.
- 4.
- 5.

Modellname: **BARCELONA**

MONTAGEANLEITUNG

TYPE T83 - GARDEROBENSCHRANK

1/1

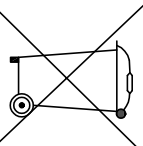

Das Symbol der durchgekreuzten Mülltonne bedeutet, dass elektrische sowie elektronische Teile nicht mit dem Hausmüll entsorgt werden dürfen. Bitte alle elektrischen/elektronischen Teile wie in der Aufbauanleitung gezeigt abmontieren und getrennt entsorgen.

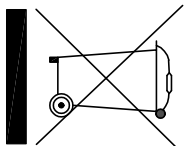

The crossed-out bin means that this product includes electrical and electronic pieces that must not be disposed of in the regular domestic waste. Please remove all electric/electronic equipment as described in the AI and dispose separately.

